



Pasta Extrusion

Introduction

The pasta extrusion process consists of several steps. After mixing semolina and water, the hydrated semolina is discharged into an extrusion barrel. In the first part of the extruder, the compression and homogenization sections, the dough is in a granular state. In the next section, the metering zone of the extruder, the material is fully melted and the domain is fully filled with the melt.

This example shows how to simulate the nonisothermal flow of the dough in the metering zone of the pasta extruder taking into account temperature dependent material properties of the hydrated semolina dough.

Model Definition

This model is inspired by [Ref. 1](#), and it consist of a screw that feeds the dough through the extrusion bell toward the extrusion holes, where the spaghetti is made. The screw consist of 10 turns. In the bell, the dough is pressed through a screen with 1-mm holes and further into two outlets with 7 spaghetti strands in each one. The material swelling after the dough exits the extrusion holes is neglected in this model. The geometry is shown in [Figure 1](#).

Since the viscosity of the melt is high, the Reynolds number, which describes the ratio of inertia to viscous forces, is low. At low Reynolds numbers, viscous forces dominate over inertia forces. Thus, the latter may be neglected in the Navier–Stokes equations and the **Creeping Flow** interface can be used.

The dough exhibits shear thinning (pseudoplastic) behavior. The power-law model is a common choice for modeling the flow of a dough. To avoid an unphysical infinite viscosity at zero shear rate, COMSOL Multiphysics implements the power-law model as,

$$\mu_{\text{app}} = m \left(\frac{\max(\dot{\gamma}, \dot{\gamma}_{\min})}{\dot{\gamma}_{\text{ref}}} \right)^{n-1} \quad (1)$$

where m is the fluid consistency coefficient, n is flow behavior index, $\dot{\gamma}_{\text{ref}}$ denotes a reference shear rate, and $\dot{\gamma}_{\min}$ is a lower shear rate limit.

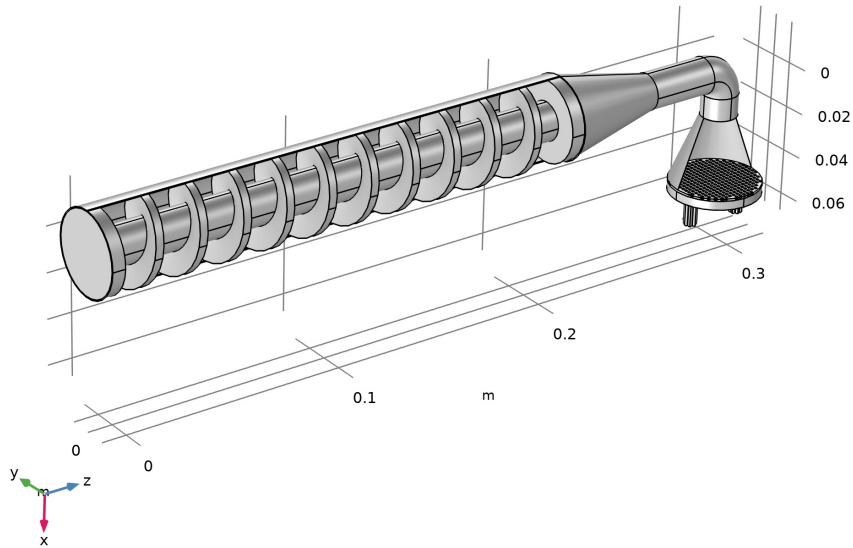

Figure 1: Geometry of a pasta screw extruder similar to the one presented in Ref. 1.

Because of viscous heating inside the barrel, the temperature variations during the extrusion operation can be significant. The viscosity of the dough decreases with temperature. To adequately describe the flow, temperature dependent material properties should be used. Rheology experiments (Ref. 1) show that the viscosity is also moisture dependent. The viscosity of the dough decreases with increasing moisture content. As moisture content rises, the influence of the temperature on the viscosity decreases. In this model, the moisture content is assumed to be constant. Temperature dependent coefficients for the non-Newtonian power-law model are obtained by interpolation from a set of measured viscosities for a range of temperatures and 30% moisture content.

To solve the equations for conservation of energy, mass and momentum in the fluid domain, the **Rotating Machinery, Nonisothermal Flow, Laminar Flow** interface is used. The interface contains a coupling between the **Creeping Flow** and the **Heat Transfer in Fluids** interfaces, and accounts for viscous dissipation.

The screw is encapsulated in a rotating domain with an angular velocity of 20 rpm. The model utilizes the frozen rotor approach to compute a steady-state flow velocity and a

temperature field. A frozen rotor analysis is a memory- and time-efficient steady-state approximation. In a sense, this approach can be described as freezing the motion of the moving part in a given position and then observing the resulting flow field with the rotor in that fixed position.

The inlet is set as an **Open boundary** with a boundary stress of 2 MPa. At the outlet, the pressure is set to 0 Pa. For the heat-transfer equation, a heat flux with a heat-transfer coefficient of $50 \text{ W}/(\text{m}^2 \cdot \text{K})$ and an external temperature of 45°C is set on all outer walls of the extruder. The inlet has a fixed temperature of 45°C , and at the outlet boundaries **Outflow** conditions are applied.

Results and Discussion

The results of the frozen rotor simulation are shown in [Figure 2](#) through [Figure 5](#).

[Figure 4](#) shows the temperature distribution. The temperature increases due to viscous heat dissipation. The viscous heating is generated in the areas with a high shear rate ([Figure 5](#)), near the wall of the barrel and inside the extrusion dies. The heat generated near the barrel wall is convected in the axial direction in a helical path along the screw.

The apparent viscosity decreases with increasing temperature ([Figure 4](#)). High values of the viscosity in the low-shear-rate zones near the rotating screw lead to poor mixing of the dough.

The velocity plot ([Figure 2](#)) shows an uneven velocity distribution in the extrusion channels. This results in different mass flow rates through the extrusion holes and may lead to varying quality of the final product.

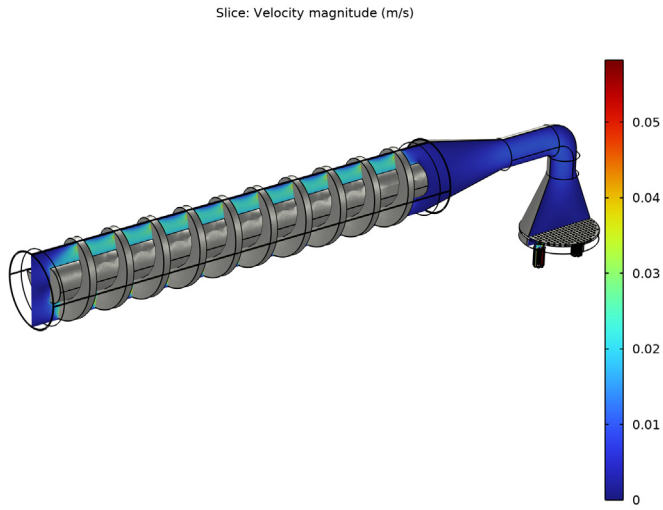

Figure 2: Velocity profile in the screw extruder.

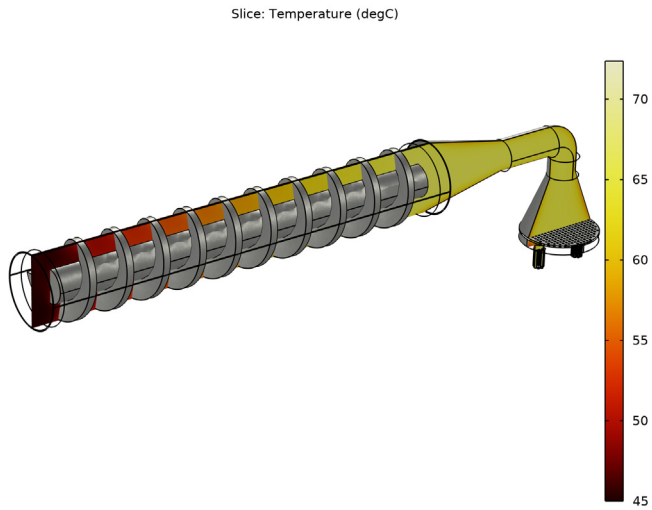

Figure 3: Temperature profile in the screw extruder.

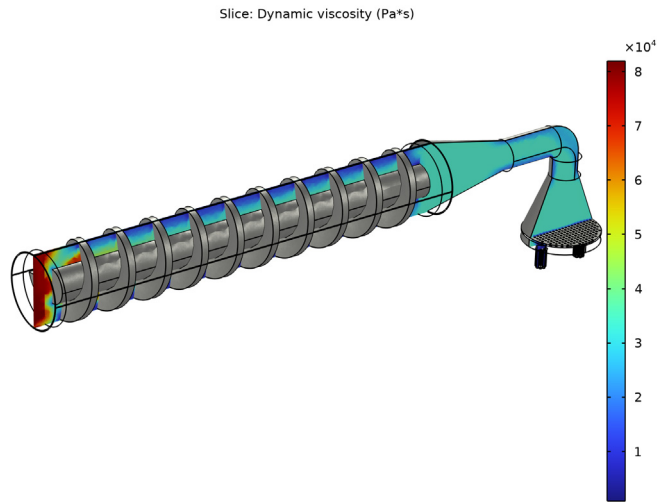

Figure 4: Apparent viscosity.

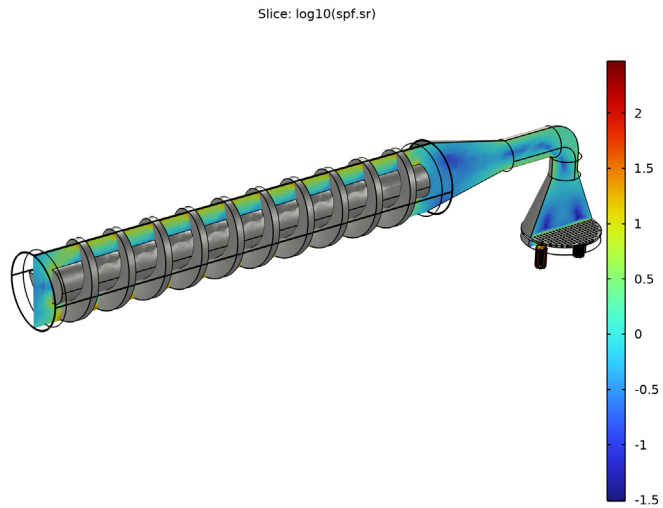

Figure 5: Shear rate.

Reference

I. F. Sarghini, A. Romano, and P. Masi, “Experimental Analysis and Numerical Simulation of Pasta Dough Extrusion Process,” *J. Food Eng.*, vol. 176, pp. 56–70, 2016.

Application Library path: Polymer_Flow_Module/Tutorials/pasta_extrusion



Modeling Instructions

From the **File** menu, choose **New**.

NEW

In the **New** window, click  **Model Wizard**.

MODEL WIZARD



- 1 In the **Model Wizard** window, click  **3D**.
- 2 In the **Select Physics** tree, select **Fluid Flow > Nonisothermal Flow > Rotating Machinery, Nonisothermal Flow > Laminar Flow**.
- 3 Click **Add**.
- 4 Click  **Study**.
- 5 In the **Select Study** tree, select **Preset Studies for Selected Physics Interfaces > Frozen Rotor**.
- 6 Click  **Done**.

GEOMETRY I

Import I (impl)

- 1 In the **Geometry** toolbar, click  **Import**.
- 2 In the **Settings** window for **Import**, locate the **Source** section.
- 3 Click  **Browse**.
- 4 Browse to the model's Application Libraries folder and double-click the file pasta_extrusion.mphbin.
- 5 Click  **Import**.

Form Union (fin)

- 1 In the **Model Builder** window, under **Component 1 (comp1) > Geometry 1** click **Form Union (fin)**.
- 2 In the **Settings** window for **Form Union/Assembly**, locate the **Form Union/Assembly** section.
- 3 From the **Action** list, choose **Form an assembly**.
- 4 Select the **Create imprints** checkbox.
- 5 Click  **Build Selected**.
Disable the analysis of the geometry as the remaining small geometric details are needed.
- 6 In the **Model Builder** window, click **Geometry 1**.
- 7 In the **Settings** window for **Geometry**, locate the **Cleanup** section.
- 8 Clear the **Automatic detection of small details** checkbox.
- 9 In the **Geometry** toolbar, click  **Build All**.

Next, define the material properties. The physics interface and the chosen fluid model will suggest which material properties are required to solve the model. Therefore, before creating a semolina dough material, choose the Power law model in the **Laminar Flow** interface.

LAMINAR FLOW (SPF)

Fluid Properties 1

- 1 In the **Model Builder** window, under **Component 1 (comp1) > Laminar Flow (spf)** click **Fluid Properties 1**.
- 2 In the **Settings** window for **Fluid Properties**, locate the **Fluid Properties** section.
- 3 Find the **Constitutive relation** subsection. From the list, choose **Inelastic non-Newtonian**.

MATERIALS

Material 1 (mat1)

- 1 In the **Model Builder** window, under **Component 1 (comp1)** right-click **Materials** and choose **Blank Material**.
- 2 In the **Settings** window for **Material**, locate the **Material Contents** section.

3 In the table, enter the following settings:

Property	Variable	Value	Unit	Property group
Fluid consistency coefficient	m_pow	m30 (T)	Pa·s	Power law
Flow behavior index	n_pow	n30 (T)	1	Power law
Heat capacity at constant pressure	Cp	2000	J/(kg·K)	Basic
Thermal conductivity	k_iso ; kii = k_iso, kij = 0	0.242	W/(m·K)	Basic
Density	rho	1200	kg/m ³	Basic

Define interpolation functions for the temperature-dependent power-law coefficients.

Interpolation 1 (int1)

- 1 In the **Model Builder** window, expand the **Material 1 (mat1)** node.
- 2 Right-click **Component 1 (comp1) > Materials > Material 1 (mat1) > Power law (PowerLaw)** and choose **Functions > Interpolation**.
- 3 In the **Settings** window for **Interpolation**, locate the **Definition** section.
- 4 In the **Function name** text field, type m30.
- 5 In the table, enter the following settings:

t	f(t)
35	109341
40	119257
45	81950
50	41705
55	33043
60	34739
80	33643

6 Locate the **Units** section. In the **Function** table, enter the following settings:

Function	Unit
m30	Pa*s

7 In the **Argument** table, enter the following settings:

Argument	Unit
t	degC

Interpolation 2 (m2)

- 1 Right-click **Interpolation 1 (m30)** and choose **Duplicate**.
- 2 In the **Settings** window for **Interpolation**, locate the **Definition** section.
- 3 In the **Function name** text field, type n30.
- 4 In the table, enter the following settings:

t	f(t)
35	0.3984
40	0.3365
45	0.3586
50	0.4510
55	0.4540
60	0.4501
80	0.2910

5 Locate the **Units** section. In the **Function** table, enter the following settings:

Function	Unit
n30	1

Pasta 30% Hydration

- 1 In the **Model Builder** window, under **Component 1 (comp1) > Materials > Material 1 (mat1)** click **Power law (PowerLaw)**.
- 2 In the **Settings** window for **Power Law**, locate the **Output Properties** section.
- 3 In the table, enter the following settings:

Property	Variable	Expression	Unit	Size
Fluid consistency coefficient	m_pow	m30(T)	Pa·s	1x1
Flow behavior index	n_pow	n30(T)	1	1x1

- 4 In the **Model Builder** window, click **Material 1 (mat1)**.
- 5 In the **Settings** window for **Material**, type Pasta 30% Hydration in the **Label** text field.

- 6 In the **Model Builder** window, collapse the **Component 1 (comp1) > Materials > Pasta 30% Hydration (mat1) > Power law (PowerLaw)** node.

The flow velocity in this model is very slow. Thus, it is safe to neglect the inertial terms of the Navier–Stokes equations and use the Stokes equation for creeping flow.

LAMINAR FLOW (SPF)

- 1 In the **Model Builder** window, under **Component 1 (comp1)** click **Laminar Flow (spf)**.
- 2 In the **Settings** window for **Laminar Flow**, locate the **Physical Model** section.
- 3 From the **Compressibility** list, choose **Incompressible flow**.
- 4 Select the **Neglect inertial term (Stokes flow)** checkbox.

To eliminate unphysical behavior of the Power law model at zero shear rate, the COMSOL Multiphysics implementation introduces a cutoff shear rate value. Modify the default minimum shear rate value according to [Ref. 1](#)

Fluid Properties 1

- 1 In the **Model Builder** window, under **Component 1 (comp1) > Creeping Flow (spf)** click **Fluid Properties 1**.
- 2 In the **Lower shear rate limit** text field, type $1[1/s]$.

MOVING MESH

Rotating Domain 1

- 1 In the **Model Builder** window, under **Component 1 (comp1) > Moving Mesh** click **Rotating Domain 1**.
- 2 Select Domain 26 only.
- 3 In the **Settings** window for **Rotating Domain**, locate the **Rotation** section.
- 4 From the **Rotation type** list, choose **Specified rotational velocity**.
- 5 From the **Rotational velocity expression** list, choose **Constant revolutions per time**.
- 6 In the f text field, type $20[RPM]$.

CREEPING FLOW (SPF)

Open Boundary 1

- 1 In the **Physics** toolbar, click  **Boundaries** and choose **Open Boundary**.
- 2 Select Boundary 11 only.
- 3 In the **Settings** window for **Open Boundary**, locate the **Boundary Condition** section.

4 In the f_0 text field, type 2[MPa].



Outlet 1

- 1 In the **Physics** toolbar, click  **Boundaries** and choose **Outlet**.
- 2 Select Boundaries 1658–1671 only.

HEAT TRANSFER IN FLUIDS (HT)

In the **Model Builder** window, under **Component 1 (comp1)** click **Heat Transfer in Fluids (ht)**.

Outflow 1

- 1 In the **Physics** toolbar, click  **Boundaries** and choose **Outflow**.
- 2 Click the  **Select Box** button in the **Graphics** toolbar.
- 3 Select Boundaries 1658–1671 only.

Temperature 1

- 1 In the **Physics** toolbar, click  **Boundaries** and choose **Temperature**.
- 2 Select Boundary 11 only.
- 3 In the **Settings** window for **Temperature**, locate the **Temperature** section.
- 4 In the T_0 text field, type 45[degC].

Heat Flux 1

- 1 In the **Physics** toolbar, click  **Boundaries** and choose **Heat Flux**.
- 2 Select Boundaries 1, 2, 5, 8, 58, 60, 62–64, 87, 88, 90, 91, 115, 117–120, 122, 123, 1571–1575, 1577, 1578, and 1580–1585 only.
- 3 In the **Settings** window for **Heat Flux**, locate the **Heat Flux** section.
- 4 From the **Flux type** list, choose **Convective heat flux**.
- 5 In the h text field, type 50.
- 6 In the T_{ext} text field, type 45[degC].

MESH 1

- 1 In the **Model Builder** window, under **Component 1 (comp1)** click **Mesh 1**.
- 2 In the **Settings** window for **Mesh**, locate the **Physics-Controlled Mesh** section.
- 3 From the **Element size** list, choose **Coarse**.
- 4 Click  **Build All**.

STUDY 1

In the **Study** toolbar, click  **Compute**.

RESULTS



Slice

- 1 In the **Model Builder** window, expand the **Velocity (spf)** node, then click **Slice**.
- 2 In the **Settings** window for **Slice**, locate the **Plane Data** section.
- 3 From the **Plane** list, choose **zx-planes**.
- 4 In the **Planes** text field, type 1.
- 5 In the **Velocity (spf)** toolbar, click  **Plot**.

To improve the visualization, it is possible to include the metal surfaces of the screw and render it as a scratched steel surface. To facilitate this, it is best to define an explicit selection of the desired surfaces.

DEFINITIONS

Metal Surfaces

- 1 In the **Definitions** toolbar, click  **Explicit**.
- 2 In the **Settings** window for **Explicit**, locate the **Input Entities** section.
- 3 From the **Geometric entity level** list, choose **Boundary**.
- 4 Click the  **Wireframe Rendering** button in the **Graphics** toolbar.
- 5 Select Boundaries 8, 15, 16, 19, 20, 23, 24, 27, 28, 31, 32, 35, 36, 39, 40, 43, 44, 47, 48, 51, 52, 57, 58, 62, 67, 69, 71, 73, 75, 77, 79, 81, 87–89, 94, 96, 98, 100, 102, 104, 106, 108, 110, 112, 119, 120, 123, 124, 126–128, 130–132, 134–136, 138–140, 142–149, 151–153, 155–157, 159–161, 163–165, 167–169, 171–173, 175–177, 179–181, 183–185, 187–199, 201–203, 205–207, 209–211, 213–215, 217–219, 221–223, 225–227, 229–231, 233–235, 237–239, 241–243, 245–259, 261–263, 265–267, 269–271, 273–275, 277–279, 281–283, 285–287, 289–291, 293–295, 297–299, 301–303, 305–307, 309–311, 313–315, 317–334, 336–338, 340–342, 344–346, 348–350, 352–354, 356–358, 360–362, 364–366, 368–370, 372–374, 376–378, 380–382, 384–386, 388–390, 392–394, 396–414, 416–418, 420–422, 424–426, 428–430, 432–434, 436–438, 440–442, 444–446, 448–450, 452–454, 456–458, 460–462, 464–466, 468–470, 472–474, 476–478, 480–499, 501–503, 505–507, 509–511, 513–515, 517–519, 521–523, 525–527, 529–531, 533–535, 537–539, 541–543, 545–547, 549–551, 553–555, 557–559, 561–563, 565–567, 569–589, 591–593, 595–597, 599–601, 603–605, 607–609, 611–613, 615–617, 619–621, 623–625, 627–629, 631–633, 635–637, 639–641, 643–645, 647–649, 651–653, 655–657, 659–661, 663–684, 686–688, 690–692, 694–696, 698–700, 702–704, 706–708, 710–712, 714–716, 718–720, 722–724, 726–728, 730–732,

734–736, 738–740, 742–744, 746–748, 750–752, 754–756, 758–779, 781–783, 785–787, 789–791, 793–795, 797–799, 801–803, 805–807, 809–811, 813–815, 817–819, 821–823, 825–827, 829–831, 833–835, 837–839, 841–843, 845–847, 849–851, 853–874, 876–878, 880–882, 884–886, 888–890, 892–894, 896–898, 900–902, 904–906, 908–910, 912–914, 916–918, 920–922, 924–926, 928–930, 932–934, 936–938, 940–942, 944–946, 948–969, 971–973, 975–977, 979–981, 983–985, 987–989, 991–993, 995–997, 999–1001, 1003–1005, 1007–1009, 1011–1013, 1015–1017, 1019–1021, 1023–1025, 1027–1029, 1031–1033, 1035–1037, 1039–1041, 1043–1064, 1066–1068, 1070–1072, 1074–1076, 1078–1080, 1082–1084, 1086–1088, 1090–1092, 1094–1096, 1098–1100, 1102–1104, 1106–1108, 1110–1112, 1114–1116, 1118–1120, 1122–1124, 1126–1128, 1130–1132, 1134–1136, 1138–1159, 1161–1163, 1165–1167, 1169–1171, 1173–1175, 1177–1179, 1181–1183, 1185–1187, 1189–1191, 1193–1195, 1197–1199, 1201–1203, 1205–1207, 1209–1211, 1213–1215, 1217–1219, 1221–1223, 1225–1227, 1229–1249, 1251–1253, 1255–1257, 1259–1261, 1263–1265, 1267–1269, 1271–1273, 1275–1277, 1279–1281, 1283–1285, 1287–1289, 1291–1293, 1295–1297, 1299–1301, 1303–1305, 1307–1309, 1311–1313, 1315–1334, 1336–1338, 1340–1342, 1344–1346, 1348–1350, 1352–1354, 1356–1358, 1360–1362, 1364–1366, 1368–1370, 1372–1374, 1376–1378, 1380–1382, 1384–1386, 1388–1390, 1392–1409, 1411–1413, 1415–1417, 1419–1421, 1423–1425, 1427–1429, 1431–1433, 1435–1437, 1439–1441, 1443–1445, 1447–1449, 1451–1453, 1455–1457, 1459–1461, 1463–1479, 1481–1483, 1485–1487, 1489–1491, 1493–1495, 1497–1499, 1501–1503, 1505–1507, 1509–1511, 1513–1515, 1517–1529, 1531–1533, 1535–1537, 1539–

1541, 1543–1545, 1547–1549, 1551–1553, 1555–1557, 1559–1569, 1573, 1574, 1582–1586, 1593, 1675, 1678, 1698–1720, and 1731–1752 only.

This is most easily done by copying the selection from the text above and pasting it in the selection area.

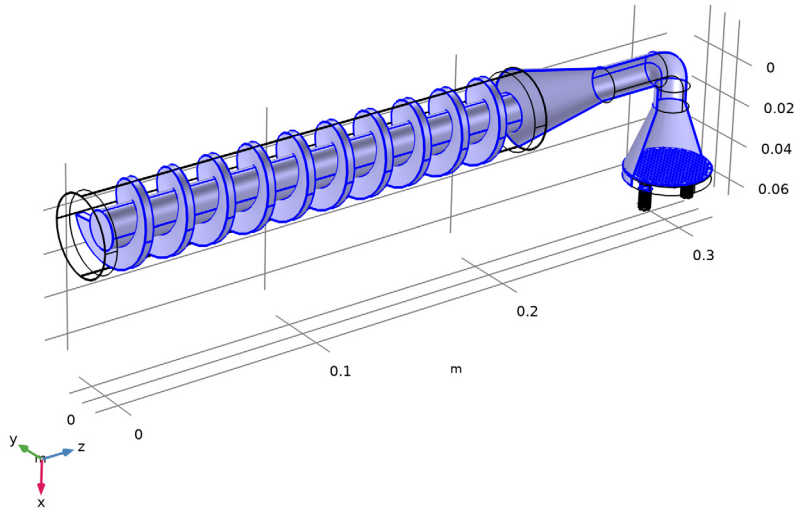

6 In the **Label** text field, type **Metal Surfaces**.

Next, add a surface plot with the previous selection. Then you can add a material appearance to render it as a scratched steel surface.

RESULTS

Surface 1

- 1** In the **Model Builder** window, right-click **Velocity (spf)** and choose **Surface**.
- 2** In the **Settings** window for **Surface**, locate the **Expression** section.
- 3** In the **Expression** text field, type **1**.
- 4** Click to expand the **Title** section. From the **Title type** list, choose **None**.

Selection 1

- 1** Right-click **Surface 1** and choose **Selection**.
- 2** In the **Settings** window for **Selection**, locate the **Selection** section.

3 From the **Selection** list, choose **Metal Surfaces**.

Material Appearance 1

1 In the **Model Builder** window, right-click **Surface 1** and choose **Material Appearance**.

2 In the **Settings** window for **Material Appearance**, locate the **Appearance** section.

3 From the **Appearance** list, choose **Custom**.

4 From the **Material type** list, choose **Steel (scratched)**.

Copy the surface plot with the metal rendered screw for use in other plot groups.

Surface 1

Right-click **Surface 1** and choose **Copy**.

Modify the temperature plot so that it looks similar to [Figure 3](#) by deleting the original surface plot and adding a temperature slice instead.

Volume 1

1 In the **Model Builder** window, expand the **Results > Temperature (ht)** node.

2 Right-click **Volume 1** and choose **Delete**.

Slice 1

1 Right-click **Temperature (ht)** and choose **Slice**.

2 In the **Settings** window for **Slice**, locate the **Expression** section.

3 In the **Expression** text field, type T.

4 In the **Unit** field, type degC.

5 Locate the **Plane Data** section. From the **Plane** list, choose **zx-planes**.

6 In the **Planes** text field, type 1.

7 Locate the **Coloring and Style** section. From the **Color table** list, choose **ThermalDark**.

Surface 1

Right-click **Temperature (ht)** and choose **Paste Surface**.

Add a new plot group and create a slice plot for the visualization of the viscosity, similar to [Figure 4](#). Include the previous surface plot of the steel screw parts.

3D Plot Group 5

In the **Results** toolbar, click  **3D Plot Group**.

Surface 1

Right-click **3D Plot Group 5** and choose **Paste Surface**.

3D Plot Group 5

In the **Model Builder** window, right-click **Surface 1** and choose **Slice**.

Slice 1

- 1 In the **Settings** window for **Slice**, locate the **Plane Data** section.
- 2 From the **Plane** list, choose **zx-planes**.
- 3 Locate the **Expression** section. In the **Expression** text field, type $\text{spf} \cdot \mu$.
- 4 Locate the **Plane Data** section. In the **Planes** text field, type 1.
- 5 In the **3D Plot Group 5** toolbar, click  **Plot**.

Viscosity

- 1 In the **Model Builder** window, under **Results** click **3D Plot Group 5**.
- 2 In the **Settings** window for **3D Plot Group**, type **Viscosity** in the **Label** text field.

Duplicate the plot group and add a plot for the shear rate.



Viscosity 1

Right-click **Viscosity** and choose **Duplicate**.

Shear Rate

In the **Label** text field, type **Shear Rate**.

Slice 1

- 1 In the **Model Builder** window, expand the **Results > Viscosity 1** node, then click **Slice 1**.
- 2 In the **Settings** window for **Slice**, locate the **Expression** section.
- 3 In the **Expression** text field, type $\text{spf} \cdot \text{sr}$.
- 4 In the **Viscosity 1** toolbar, click  **Plot**.
- 5 In the **Expression** text field, type $\log_{10}(\text{spf} \cdot \text{sr})$.
- 6 In the **Viscosity 1** toolbar, click  **Plot**.

