

Advanced multi-physics models for the optimization of the hot extrusion process of light alloys

R. Pelaccia¹, B. Reggiani¹, M. Negozio², S. Di Donato³, L. Donati³

1. DISMI - Department of Sciences & Methods for Engineering. University of Modena & Reggio Emilia, Reggio Emilia, Italy.

2. DISTI- Department of Engineering for Industrial Systems and Technologies University of Parma, Parma, Italy.

3. DIN- Department of Industrial Engineering, University of Bologna, Bologna, Italy.

Abstract

Aluminum extrudates have become prominent in several industrial fields such as furniture design, railway transportation and construction due to their high flexibility in shape complexity, high strength-to-density ratio and corrosion resistance. In response to the growing demand for high-quality and complex profiles, numerical simulation offers a competitive solution for process optimization, scrap reduction and productivity enhancement. In this context, this work aims to present innovative numerical models developed within COMSOL Multiphysics® for simulating the extrusion process. Several industrial case studies were presented, discussed and simulated by coupling different modules (Laminar Flow, Heat Transfer with Solid and Fluid, Solid Mechanics, Non-Isothermal Pipe Flow, Topological Optimization, Phase Field) depending on specific objectives.

Keywords: Extrusion Process, Aluminum Alloys, Multi-physics models, Multi-Objective Optimization.

Introduction

During the hot extrusion process, a cylindrical pre-heated billet is inserted into a container and is forced by a hydraulic press to flow through a shaped die in order to obtain, as final product, a profile with a constant cross-section [1] (Fig. 1a). High flexibility in shape complexity, good mechanical properties and possibility of recycling materials such as aluminum alloys, has promoted extrudates for the use in many applications. In this context, the required complex profiles, usually marked by many details, appendices and thin sections, involve high-quality product and process design, achievable only with the support of the numerical simulations. In literature, many works deal with case studies to implement, calibrate, and validate numerical models for the extrusion process [2-4] (die design, scrap reduction, process optimization). Therefore, this work aims to present and describe innovative 3D numerical models for

the extrusion process implemented within COMSOL Multiphysics® that combine different modules. Several industrial case studies were discussed to show and handle some challenges for the advanced optimization of the process through numerical simulation. Notably, with respect to commercial software specifically dedicated to extrusion, it is possible to implement customized and flexible models for analyzing the entire process from different points of view.

The 3D Model of the Extrusion Process

Figure 1 compares the schematization of the extrusion process with its modelling within the COMSOL environment. A pure Eulerian approach is selected with the 3D billet modelled in already deformed condition (Fig. 1b). The laminar flow module, to treat the aluminum as Non-Newtonian fluid at very high viscosity depended on strain rate and temperature [5], and the Heat Transfer with Solid and Fluid module, to consider the heat

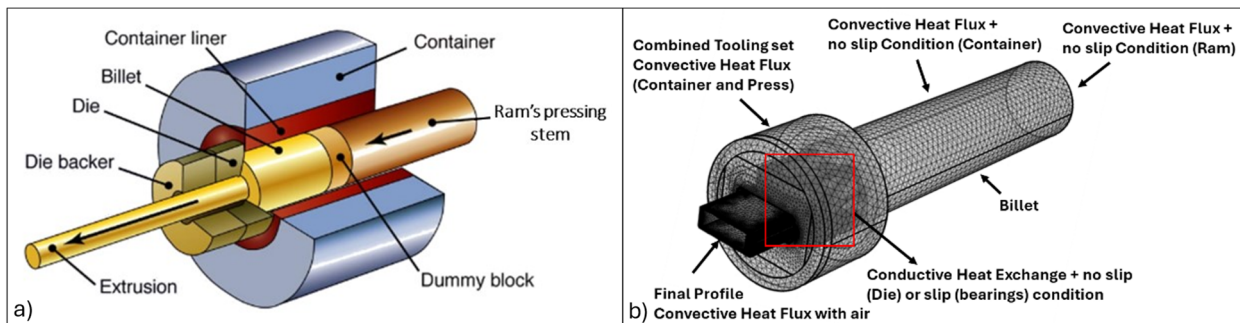

Figure 1 The hot extrusion process of light alloys: a) Schematization of the process; b) Example of 3D model implemented on COMSOL

generated by friction forces and the deformation energy, are coupled to simulate the extrusion process.

The container, that encompasses the billet, and the ram, that forces the billet to be deformed within the die, are replaced with equivalent thermal and frictional boundary conditions in order to reduce the computational time. More in detail, the heat exchange between aluminum and steel (container and ram with the billet) and the one between steel parts (container and die, die with cold part of the press...) are simulated with convective heat fluxes (heat transfer coefficient aluminum-steel $11000 \text{ W}/(\text{m}^2\text{K})$, steel-steel $3000 \text{ W}/(\text{m}^2\text{K})$). In addition, the convective heat transfer with air is also considered at the exit from the die ($50 \text{ W}/(\text{m}^2\text{K})$). According to the state of art [1], no-slip condition is imposed on all aluminum surfaces in contact with the tooling set, except on the bearings, where the profile obtains its final shape and where the high involved velocities guarantee a slip condition. If a die-stress analysis is necessary to assess the quality of the die design, the Solid Mechanics module should be added. The aluminum under deformation applies pressure on the die, which, since it is mounted and fixed within the press, is subjected to a compression state. Therefore, rigid fixing constraint is imposed on the exit die surface that would be bound by the press, aluminum pressure field calculated by the Laminar Flow module is imposed as external stress, and the temperature field obtained by the Heat Transfer with Solid and Fluid module is taken into account in order to perform a thermo-structural analysis of the extrusion die. Elastoplastic material model is recommended to obtain an accurate prediction of the die stress. In the field of scrap reduction, the Phase field module can be coupled to the Laminar Flow one to assess the profile length contaminated by the material interaction between two subsequent billets (Fig.2), which is characterized by lower mechanical properties.

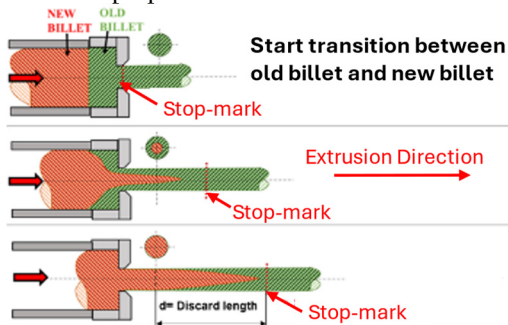

Figure 2 Schematization of the material interaction between two subsequent extruded billets

In addition, the same multi-physics allows for analyzing air-aluminum interaction with the aim of studying the die filling during the first extrusion run. Indeed, the failed filling can occur when the die is improperly designed; however, it is not

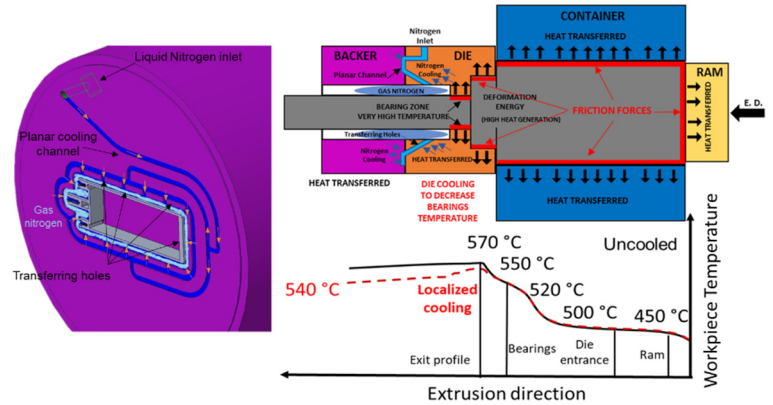

Figure 3 Schematization of extrusion process with nitrogen cooling

possible to capture this issue with only the Laminar Flow module and the billet in the already deformed condition. Moreover, the use of liquid nitrogen cooling has become necessary to reduce both die and profile temperatures as well as to increase the production rate. Indeed, the temperature field results from the energy generated by friction at the billet/tools interfaces and the massive amount of deformation energy imposed to obtain the desired shape of the extrudate, both of which are converted into heat. In addition, heat generation increases along with extrusion speed, while the exit profile temperature shall remain lower than a threshold value to avoid defects on the final surface, thus imposing a constraint on production rate. In this context, the industrial practice involves manufacturing cooling channels around the bearing zones, where the highest temperatures are reached (Fig.3). In order to evaluate the cooling efficiency of the selected design, the Non-Isothermal Pipe Flow module can be used to couple the 3D model of the extrusion process with the 1D model of the cooling channel (Fig. 5). An approach based on the Homogenous fluid model, where nitrogen is modelled as a single-phase fluid, with its thermophysical properties being a function of the conditions to which it is subject (e.g., heat exchange, pressure drop), allows capturing the effect of phase change on the cooling efficiency without an excessive increase of computational time. The Topology Optimization module can be preliminary used to find an optimal cooling path that can subsequently be engineered. A 2D model of the backer (third plate in contact with the die where cooling channels are manufactured) is chosen as solid geometry that is “virtually milled” by the nitrogen flow to satisfy specific objective functions (e.g. uniform cooling around the bearings). In the next sections, some collected case studies are summarized and discussed to demonstrate the potential of the numerical models developed within COMSOL Multiphysics® for the hot extrusion process of light alloys. In addition, an innovative procedure for multi-objective optimization is shown, in which COMSOL and Matlab environment are integrated within the

modeFRONTIER optimization platform in order to automatically re-design a parametric die geometry by following several objective functions. All exploited theories, assumptions, and equations are thoroughly addressed within the cited papers that detail each work.

Case Study 1: Multi-die design with conformal cooling channel

In this case study, an insert for extrusion die was manufactured with selective laser melting (SLM) technology with the aim to realize within it a helicoidally cooling channel that surrounds and follows the bearings in the extrusion direction [6-7]. The AISI H13 die was therefore split into two parts in order to reduce the high costs of the additive manufacturing process: the insert that contained the bearings, the cooling channels and the hole for the thermocouple, and an external steel housing made with conventional chip removal processes. The experimental campaign involved designing (Fig.4a), manufacturing (Fig. 4b, using a SISMA Industries MYSINT 100 LM Fusion Fiber laser; H13 powder with an average size of 30µm) and testing of the SLM insert.

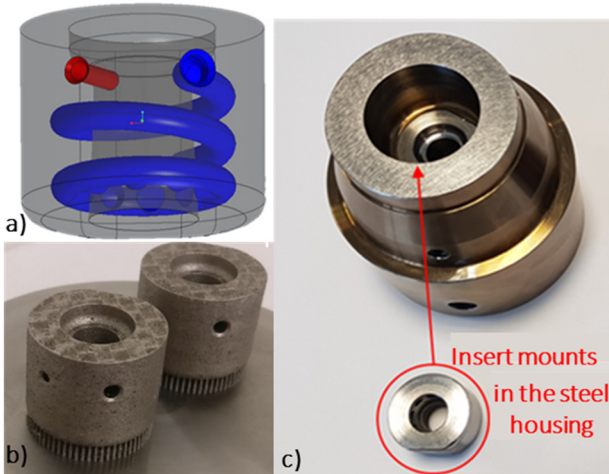

Figure 2 Die set for the experimental trials: a) Design of the insert: cooling channel in blue, hole for the thermocouple in red; b) Manufacturing of the insert with the SLM machine; c) The die set before insert assembling

A 250-tons hydraulic press was used for the extrusion of 24 billets made of AA 6063 aluminum alloy and 18 made of ZM2 magnesium alloy, by replicating on a laboratory scale the production volume and the die stress of typical industrial standards. In the trials with aluminum alloy, nitrogen cooling was tested at two levels of ram speed (4.2 and 6.5 mm/s) to highlight the benefits of targeted heat removal in terms of productivity increase. Figure 5 shows the geometrical model implemented within COMSOL: the extruded profile was a 10 mm round bar obtained by a billet with a length of 100 mm and a diameter of 45 mm, the 1D cooling channel was integrated within the insert.

Four modules were coupled to perform the transient simulation of the process: Laminar Flow, Heat Transfer with Solid and Fluids and Non-Isothermal Pipe Flow to predict the thermal field and the extrusion loads, while the Solid Mechanics to evaluate the die stress in both uncooled and cooled condition.

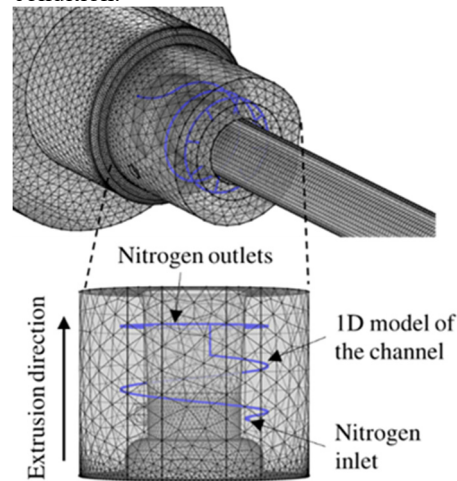

Figure 3 Geometrical Domain for case study 1

Table 1 summarizes the process parameters, while Figure 6 shows the experimental-numerical comparison in terms of temperatures recorded by the thermocouple positioned near the bearings. The transient simulation covered four extrusion runs without nitrogen cooling (billets 4-7), fourteen with nitrogen valve fully opened (billets 8-21), and three with nitrogen cooling and the ram speed increased from 4.2 to 6.5 mm/s (billets 22-24). During the uncooled process, the simulations well captured the peak of temperature characteristic of the extrusion as well as the cooling down during the billet change, evidencing a good overlap with experimental data. When the nitrogen valve was fully opened, a significant overestimation of the cooling was found (billet 9), because a high formation of gas nitrogen plugged the channel drastically reducing the initial nitrogen flow rate, a phenomenon not easily caught using a fully developed flow.

Table 1 Process Parameters and boundary conditions set for the transitory analysis.

Process Parameters	Value
Billet Temperature	450 °C
Die Temperature	450 °C
Container Temperature	376 °C
Ram Temperature	280 °C
Ram Speed	4.2/6.5 mm/s
Ram, Container/billet interface	No slip + Convection
Die/billet interface	No slip + Conduction
Bearings/billet interface	Slip + Conduction
Inlet Nitrogen Pressure	4 bar

Inlet Nitrogen Temperature	-196 °C
Nitrogen Properties	$f(T)$ [7]

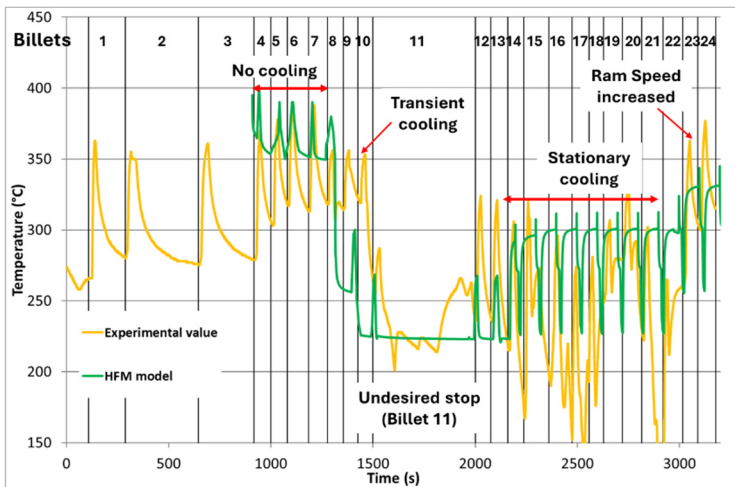

Figure 4 Experimental-numerical comparison of the temperature history registered by the thermocouple

However, after the first transitory phase, despite the experimental temperature fluctuation caused by manual control of the nitrogen valve system, the actual trend was well predicted using the HFM model both in the range from billet 14 to billet 22 (error of 3.4% if compared to the average value of 300°C) and also when the extrusion speed was increased (maximum error below 10%). In terms of extrusion load, a maximum overestimation of 11% was found (billet 7, 0.98 MN vs 1.09 MN). Figure 7 shows the insert stress analysis of cooled process (billet 18). An average value of 700 MPa was detected by the model with a peak of 1000 MPa due to the high thermal stresses. However, the level of the predicted Von Mises stresses remained under the yielding point, thus suggesting a proper resistance of the insert, as confirmed by the experimental trials (insert resisted the whole campaigns by testing both aluminum and magnesium alloys).

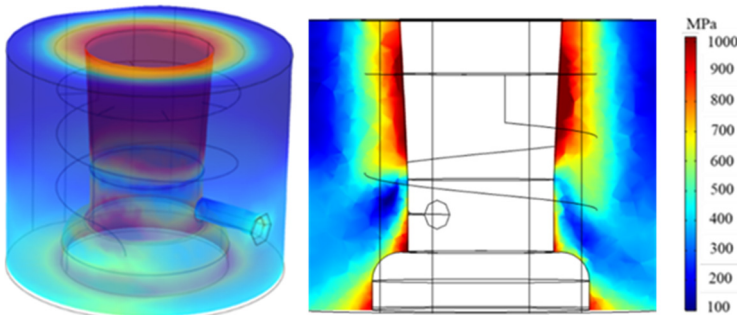

Figure 7 Von Mises stresses on the insert in cooled condition (billet 18)

Case Study 2: Phase field method for the assessment of the new-old billet material interaction

Figure 2 shows that, since the extrusion is performed in continuous process, a certain length of the profile is contaminated by the interaction between the old and the new billet material for each run. This contaminated length is unavoidable scrap (low mechanical properties) that must be optimized (excessive scrap means good material does not sell and vice versa). The Phase field interface module was chosen, where the Cahn-Hilliard equation [8] was used to describe the interaction between two immiscible fluids, which, in this case, were the new and the old billet material. The model parameters were calibrated to properly capture, during the extrusion, the interaction between solids under deformation even if they have been numerically modeled as fluid at high viscosity [9]. The experimental-numerical comparison was performed in terms of scrap assessment, by evaluating the defect evolution on the cross section of the profile. The profile length to be scrapped is measured relative to a reference point called a stop-mark, an unavoidable sign obtained on the profile surface that exits from the bearings immediately after the new extrusion starts. The defect is considered extinguished when the profile section is filled by the material of the new billet for more than 95% of its area. Figure 8 shows the defect evolution for a tube industrial profile [9]: in red the new billet material that replaces the old one for both experimental and numerical analysis. The good accuracy of the numerical prediction appears evident by comparing the defect evolution as a function of the distance from the stop-mark. The numerical results become more relevant by considering that the experimental analysis is a time and cost consuming activity involving cutting, polishing, and chemical etching of the profile, while the industrial practice is still based on empirical, but not accurate, empirical formulas.

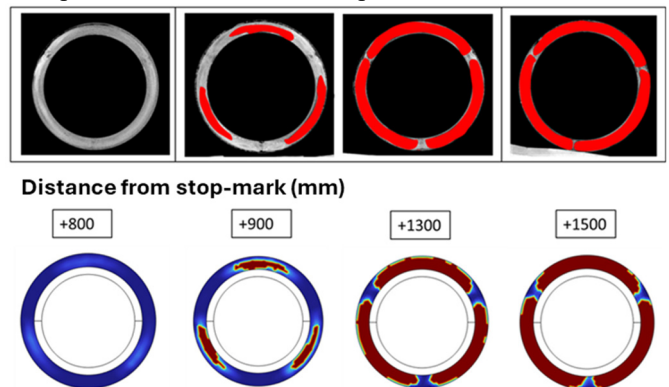

Figure 8 Experimental-Numerical assessment of the old-material replacement at different distances from the stop mark [9]

Case Study 3: Cooling Channel re-design by means of topological optimization module

The topological optimization module was used to re-design the cooling path proposed by the die maker, because it led to a low cooling efficiency [10-11]. More in detail, the optimization was based on the density method, and, by using the Darcy's Law module combined with Heat Transfer in Porous Media one, the 2D model of the backer was treated as a porous media with the porosity and the other physical properties controlled with penalization functions. Therefore, the element of the mesh with a porosity equal to zero was considered solid with the physical properties of the steel, while the element with a porosity equal to one was treated as liquid nitrogen. As shown in figure 9a, one inlet (standard for extrusion nitrogen plant) and ten outlets surrounding the outgoing profile were chosen as boundary conditions. In addition, eleven temperature control points were added to impose the objective function of reaching homogenous cooling.

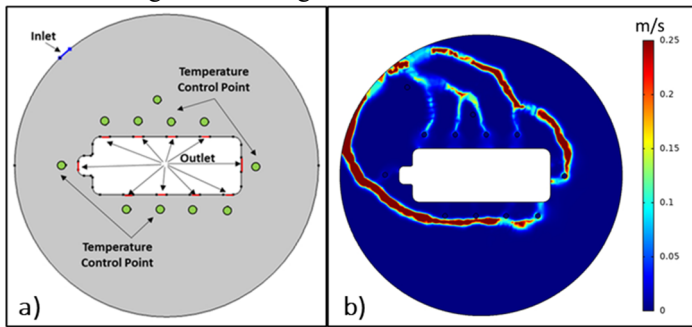
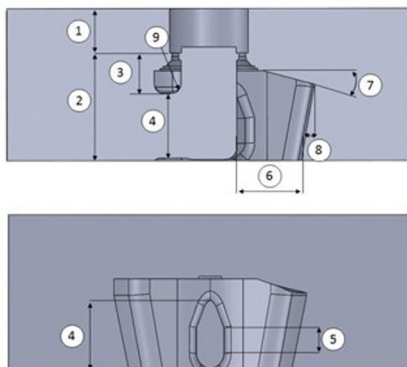

Figure 9 Topological optimization of cooling channel on backer surface: a) Problem setting, b) Velocity field along the nitrogen path proposed by the optimizer

A convective heat flux perpendicular to the backer plane was defined as additional boundary condition (heat transfer coefficient of 11000 W/(m²K) at a temperature of 550°C) with the aim to replicate in a simplified way the heat exchange between the backer and the hot die. A maximum diggable volume of 25% was imposed to respect technological constraints in terms of channel manufacturing, while a maximum inlet pressure of 5 bars was set to not exceed the maximum available



Variable	LB	UB
Height of welding chamber (2) [mm]	84	116
Height of legs (4) [mm]	20	39
Width of ports (6) [mm]	80	97.5
Die entry angle (7) [deg]	45	90
Degree of undercut on ports (8) [deg]	161	195
Fillet radius on mandrel-legs (9) [mm]	2	15

Figure 11 Parametrization of die design and geometric variables selection for case study 4

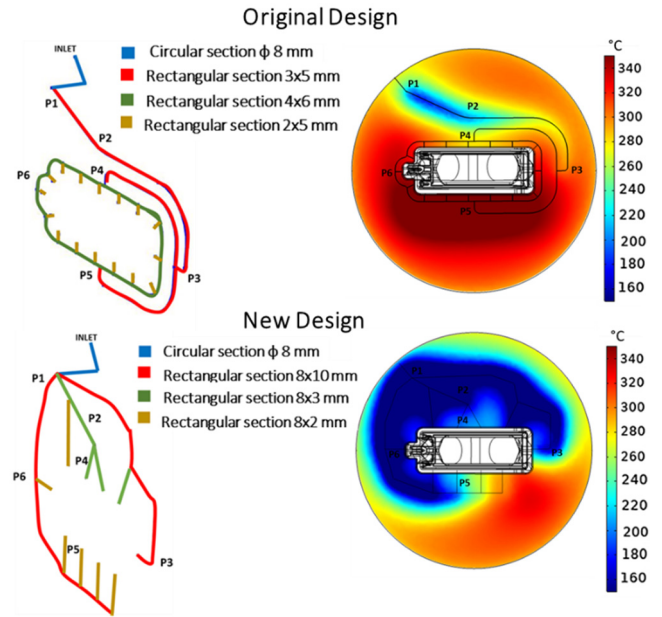

Figure 10 Numerical comparison between the original design and the optimized one in terms of cooling efficiency: Thermal field on backer surface where the thermocouples were located.

for the nitrogen plant used during the experimental trials. The optimization problem was solved using the Method of Moving Asymptotes (MMA) [12]. Figure 9b shows the velocity profile of the nitrogen flow after 280 iterations of the optimizer (computational time of 10h). The results obtained from the topological optimization was then used to design the new cooling channel. Figure 10 compares the thermal fields of the backer obtained with the original cooling path and the optimized one. As presented in the previous sections, the 3D model of the extrusion process was coupled with the 1D model of the cooling channel by using the HFM approach to take into account the effect of nitrogen phase change. The same process parameters and boundary conditions were selected for both cooling channel designs to replicate the experimental conditions [10-11]. A great cooling efficiency was obtained in the backer with the new design, underlined by the large blue area around the exit of the profile, except near the right corner of the lower side, where the

simulation predicted the gas formation. Therefore, the obtained results showed the benefits of the approach based on topological optimization, since the original design had not produced substantively a significant decrease in temperature.

Case Study 4: Multi-objective optimization of extrusion die

Proper design of an extrusion die is a complex task because several aspects must be taken into account such as the die resistance, the die filling that is correlated to the obtaining of a good final profile shape, the thermal field involved during the process, the scrap reduction as well as the mechanical properties of the extrudate. In addition, the different objective functions to be achieved could be in conflict with each other. For example, the length of the bearings can be increased to handle the material flow unbalances, however, this leads to higher friction forces and consequently to higher extrusion load and exit profile temperature. As other example, by increasing the volume where the material under deformation can flow, the weld quality in hollow profiles increases, however, the die can present smaller resistance sections and consequently more likely to get damaged. In this context, an innovative procedure for the multi-objective optimization of the extrusion process was proposed, where a parametric die design was automatically modified by following several objective functions. SOLIDWORKS® CAD software and COMSOL were integrated within the optimization platform of modeFRONTIER®.

More in detail, starting from an initial training population of die design tested automatically on COMSOL, an iterative procedure managed by genetic algorithms changes the geometrical parameters of the die selected as variables, the CAD node rebuilds the new die design, then COMSOL node tests it (the batch node launches the .m file within COMSOL with Matlab). A porthole die to extrude a round 6-mm thick tube profile (external diameter of 62.8 mm) was selected as case study [13]. Within a three equal-spaced (120°) legged mandrel, the aluminum flow was divided over three portholes, then rejoining in the welding chambers, where the material was forced to flow into the cavity between the mandrel and the die, thus obtaining the final hollow profile by means of the bearing zones. In this case, the original die design (V_0) showed marked propagated cracks after 64 extruded billets that led to the die discard. Therefore, one of the main objectives is to reduce the die stress to avoid its breakage. Figure 11 shows the parametrization of the die design: lower bounds (LW) and upper bounds (UB) were properly selected to respect geometrical constraints imposed by the press and guarantee the die's feasibility. The prescribed goals were the minimization of the peak principal tensile stress, responsible for the fracture initiation and propagation, the increase of average pressure within

the welding chamber, correlated to the mechanical resistance of hollow profiles, and the increase of ram speed, correlated to the productivity, all by keeping under control the thermal field (temperature near the melting point leads to burns on the profile surface) and the velocity of the profile (unbalanced flow can lead to incorrect profile shape). A total of 144 designs were automatically run by modeFRONTIER® within COMSOL without performing any optimization, then, based on the training results, multiple response surfaces were created, one for each output variable, by using the radial basis functions (RB). The Non-dominated Sorting Genetic Algorithm (NSGA-II) was used to find with the meta-models the optimal die design by following the imposed objective functions. More in detail, the 144 training design were tested in about 10 hours, while the subsequent 14400 configurations (144 design * 100 generations) in 0.51 seconds by using the obtained meta-models. Finally, the optimal selected design and the original one were simulated again within COMSOL by comparing the obtained results. In figure 12 is reported the response of the meta-models in the output space average welding

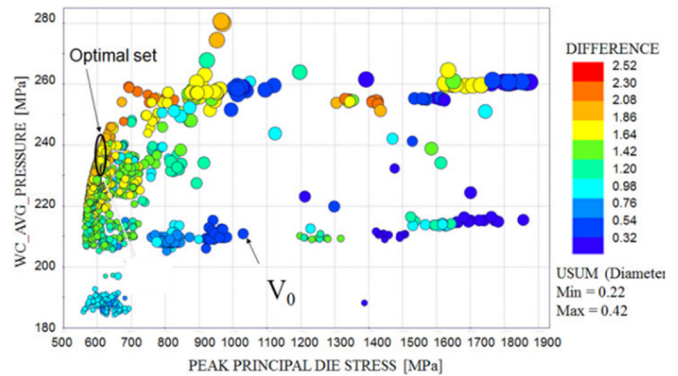

Figure 12 Design space evaluated by means of RB meta-models reported in a bubble chart 4D

pressure (Y-axis) - peak principal die stress (X-axis). The colors and dimensions of the bubbles are proportional to the relative exit speed difference and to the peak mandrel displacement respectively. The experimental tested geometric configuration V_0 and the optimal set of designs that reduce the principal stress and/or increase the welding chamber pressure are marked. The selected optimal design guaranteed, at double ram speed, to reduce the peak principal die stress of 46% and to increase the weld quality by 50% without significant detrimental effects in terms

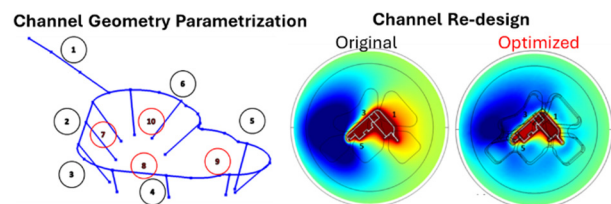

Figure 13 Multi-objective optimization of cooling channel for extrusion dies [14]

of material flow, temperature distribution, and the extrusion load. The same presented procedure can be applied to optimize the cooling channels for nitrogen cooling [14]. Figure 13 shows that, by parametrizing the channel dimension along the cooling path, it is possible to optimize its efficiency (balanced and uniform cooling after the optimization). Notably, the channel was divided into 10 segments within the COMSOL model in order to set the channel heights along the cooling path as input variables for the optimizer. A total of 100 designs (10 initial design*10 generations) were evaluated in 12 hours, by selecting as objective function the temperature balancing around the bearings and the minimization of nitrogen consumption. The optimal design presented temperature differences below 16°C around the bearings and the reduction of about 60% in terms of nitrogen flow rate.

Conclusions

Different modules were coupled to generate advanced models able to assess the hot extrusion process from different points of view. The accuracy of numerical predictions was demonstrated in terms of extrusion load, thermal field, scrap assessment, cooling efficiency, and die stress analysis. The experimental-numerical comparisons also showed the limits of industrial practices, sometimes based on experience and/or empirical approaches. Additionally, advanced iterative procedures based on the use of genetic algorithms evidenced the concrete possibility of automatically optimizing the die design as well as the entire process concerning the objectives to be achieved.

Fundings

PNRR-M4C2INV1.5, NextGenerationEU-Avviso 3277/2021 -ECS_00000033-ECOSISTER-spk 3

References

- [1] L. Donati, B. Reggiani, et al., "Advancements in extrusion and drawing: a review of the contributes by the ESAFORM community", *Int. J. Mater. Form.* 15, 41, 2022.
- [2] E. Giarmas, D. Tzetzis, "Optimization of die design for extrusion of 6xxx series aluminum alloys through finite element analysis: a critical review", *Int. J. Adv. Manuf. Technol.* 119, pp. 5529–5551, 2022.
- [3] C. Zhang, Y. Dong, et al., "Experimental and numerical investigations on transverse weld of hollow aluminum profile during porthole extrusion process", *Procedia Eng.* 207, pp. 1653-1658, 2017.
- [4] D. Pazeto, J.L.J Pereira, et al., "Numerical simulation and multiobjective optimization of fluid–structure interaction in aluminum extrusion", *Int J Adv Manuf Technol* 124, pp. 545–566, 2023.
- [5] M. Nourani, A.S. Milani, et al., "On the effect of different material constitutive equations in modeling friction stir welding: A review and comparative study on aluminum 6061" *Int J Adv Eng Technol* 7, pp. 1–20, 2014.
- [6] B. Reggiani, I. Todaro, "Investigation on the design of a novel selective laser melted insert for extrusion dies with conformal cooling channels", *Int. J. Adv. Manuf. Technol.* 104, pp. 815-830, 2019.
- [7] R. Pelaccia, M. Negozio, et al., "Extrusion of Light and Ultralight Alloys with Liquid Nitrogen Conformal Cooled Dies: Process Analysis and Simulation", *J. Mater. Eng. Perform.* 31, pp. 1991-2001, 2021.
- [8] J. Kim, "Phase-Field Models for Multi-Component Fluid Flows", *Communications in Computational Physics* 12(3), pp. 613-661, 2012.
- [9] S. Di Donato, R. Pelaccia and M. Negozio, "Phase Field Method for the Assessment of the New-Old Billet Material Interaction during Continuous Extrusion Using COMSOL Multiphysics", *J. of Materi Eng and Perform*, 2024.
- [10] R. Pelaccia, B. Reggiani, et al., "Liquid nitrogen in the industrial practice of hot aluminium extrusion: experimental and numerical investigation", *Int J Adv Manuf Technol.* 119, pp. 3141–3155, 2022.
- [11] R. Pelaccia, B. Reggiani, et al., "Investigation on the topological optimization of cooling channels for extrusion dies", *Mater. Res. Proc.* 28, pp. 533-542, 2023.
- [12] X. Zhao, M. Zhou, et al., "A "poor man's approach" to topology optimization of cooling channels based on a Darcy flow model", *Int. J. Heat Mass Transf.* 116, pp. 1108-1123, 2018.
- [13] B. Reggiani, L. Donati and L. Tomesani, "Multi-goal optimization of industrial extrusion dies by means of meta-models", *Int J Adv Manuf Technol* 88, pp. 3281–3293, 2017.
- [14] R. Pelaccia, M. Negozio, et al., "Assessment of the Optimization Strategy for Nitrogen Cooling Channel Design in Extrusion Dies", *Key Eng Mater.* 926, pp. 460–47, 2022.