

Deep Learning Enabled Nanophotonic Design via Finite Element Simulation

Abhishek Mall^{1,2}, Patil Abhijit Tukaram², Amit Sethi², Anshuman Kumar¹

1. Laboratory of Optics of Quantum Materials, Department of Physics, IIT Bombay, India
2. Medical Imaging Deep Learning Artificial Intelligence Lab, Department of Electrical Engineering, IIT Bombay, India

abhishekmall@iitb.ac.in



Outline

- Motivation.
 - Metamaterials and Metasurfaces.
 - Finite Element Approach, Data-Driven Approach .
- Machine Learning Models.
 - Deep Neural Networks(DNNs) .
 - Generative Adversarial Networks(GANs).
- Simulation and Results.
- Conclusions.

Metamaterials and Metasurfaces

- Tunable Metasurface.

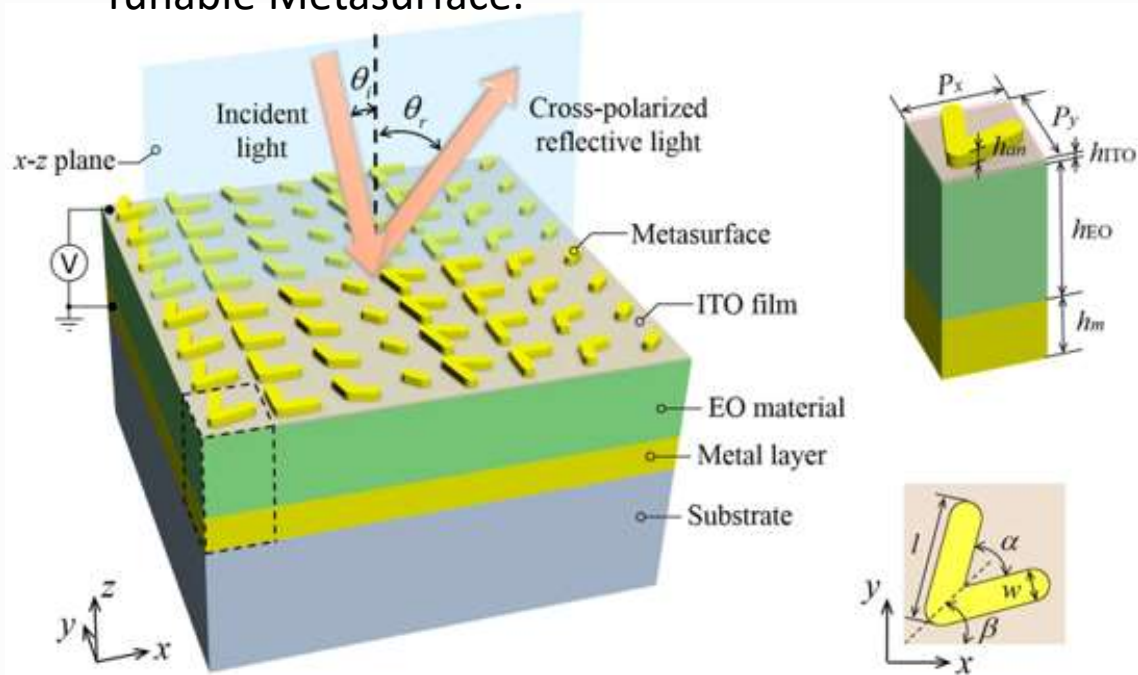

Jingjing Guo, Scientific REPORTS | 7: 14078

Tapashree Roy et al.2017 ,Acsnano

N. Yu et al. (2011)

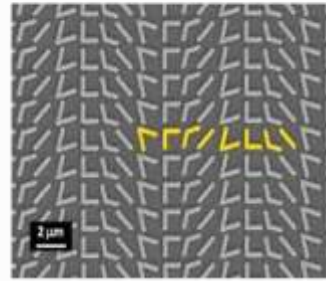
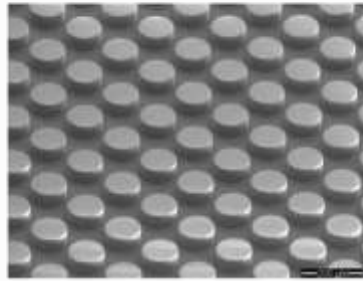
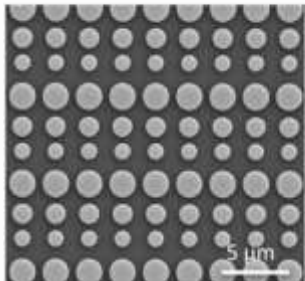

- Meta-Lens.

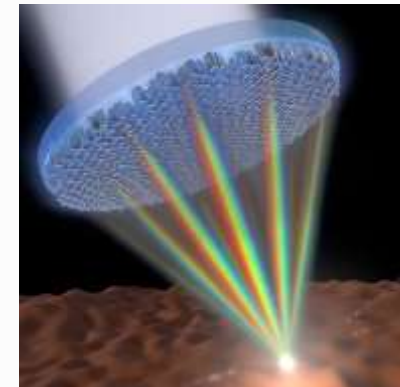
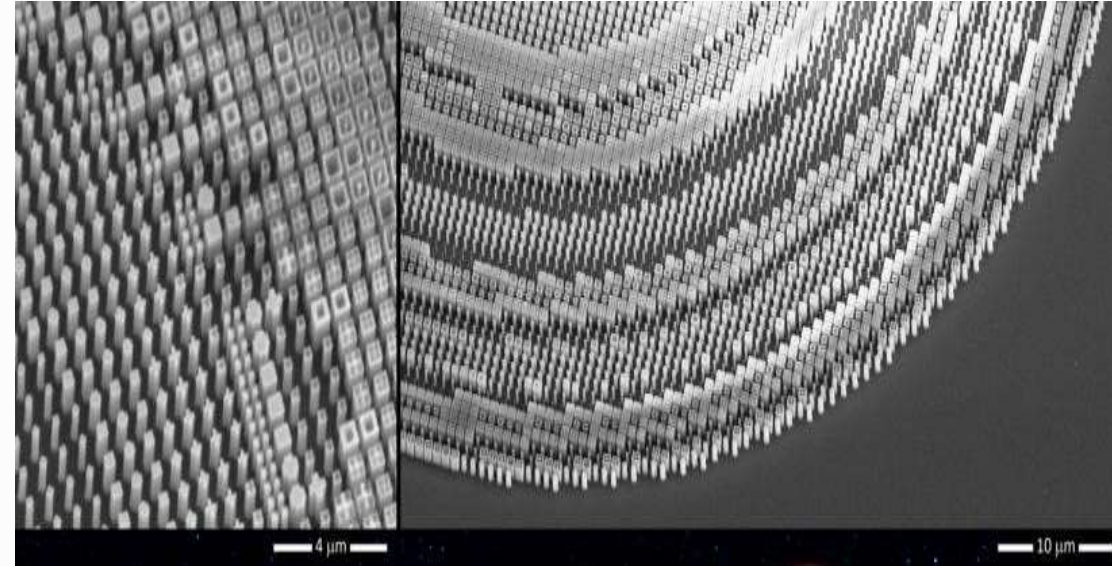

Sajan Shrestha,

Light: Science & Applications, volume 7, Article number: 85 (2018)

Why Machine Learning?

- Conventional Approach.

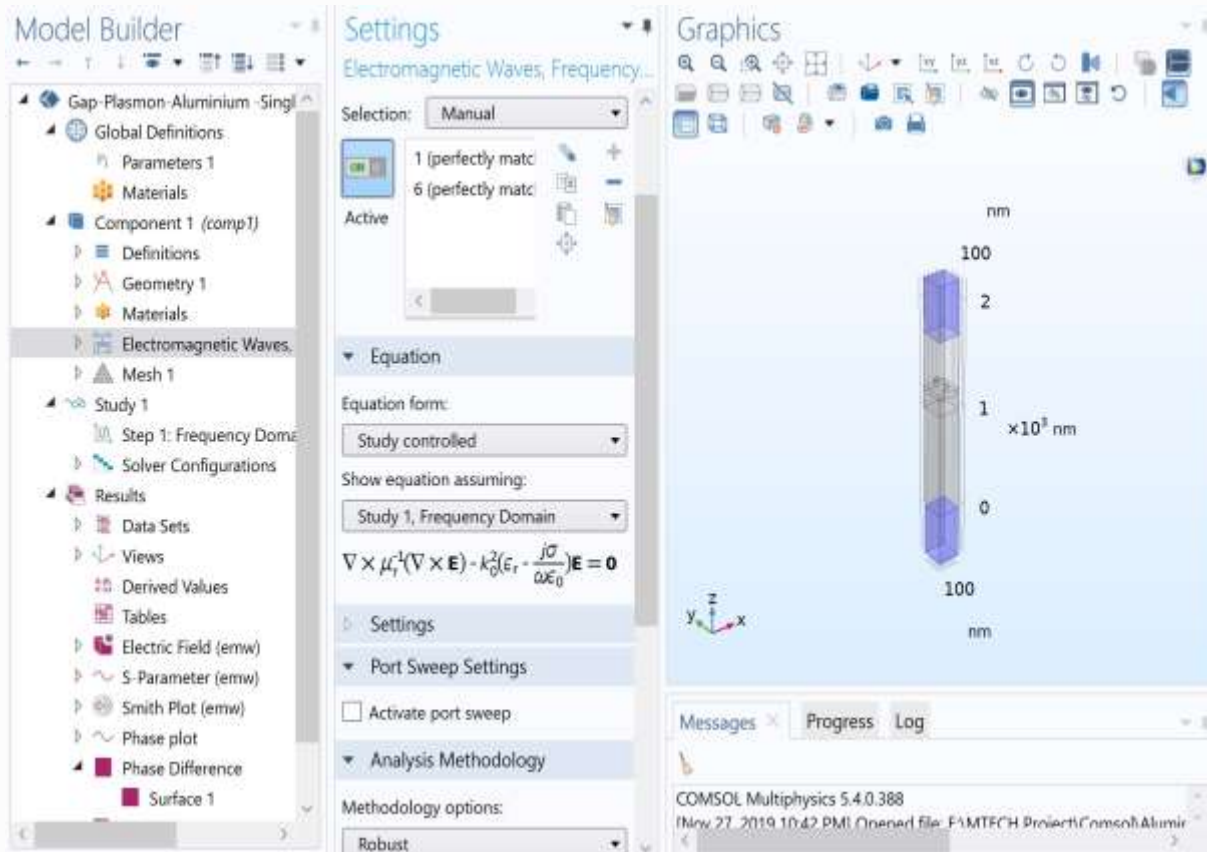

- Data-driven Approach.

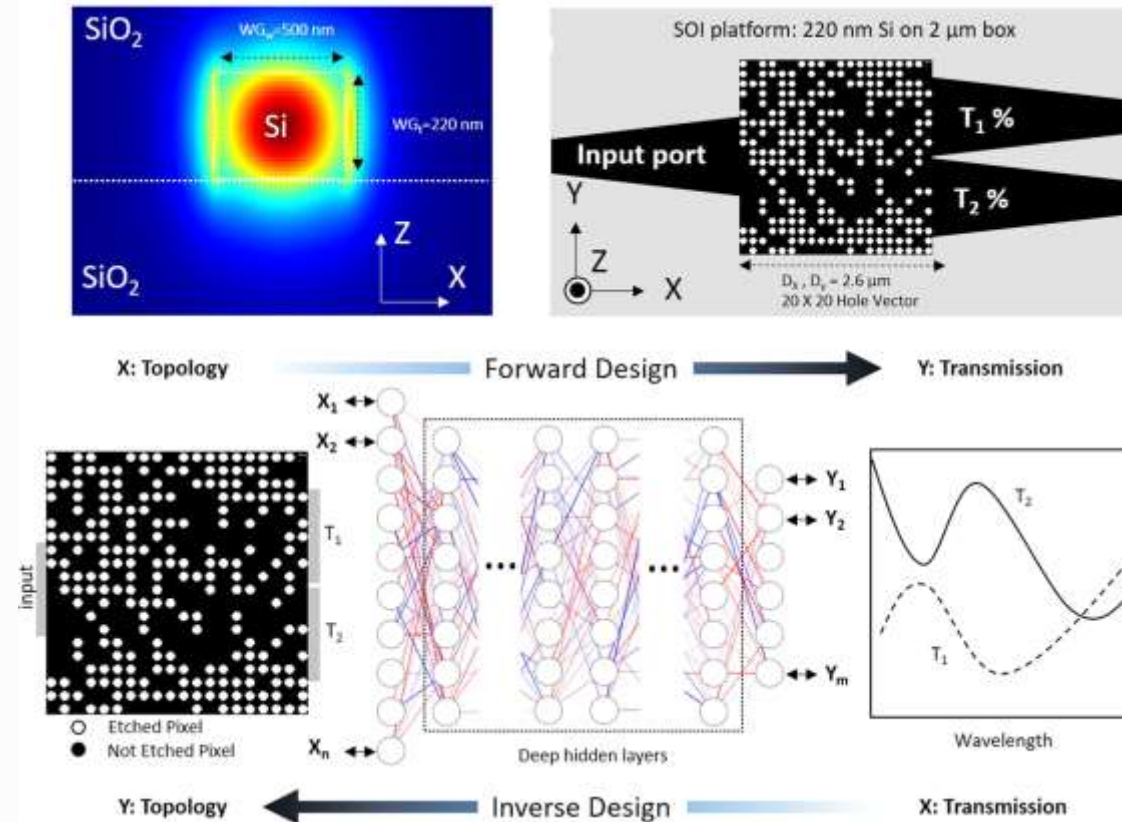

Machine learning Models

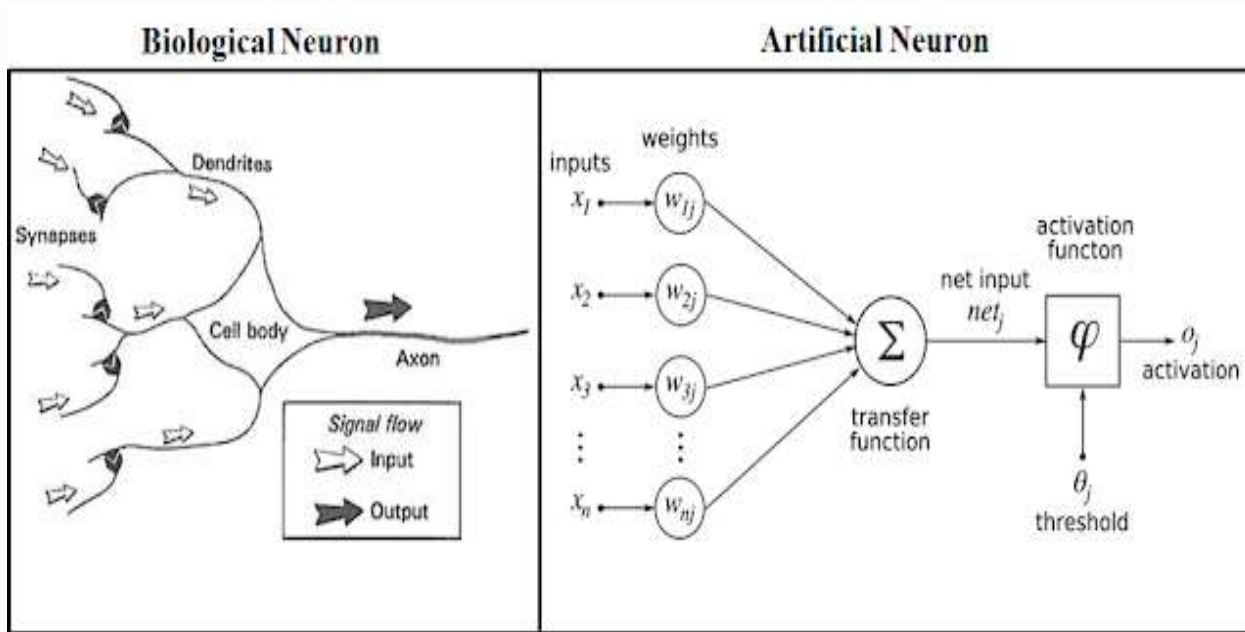

Data Science and Neural Networks

Deep Neural Networks

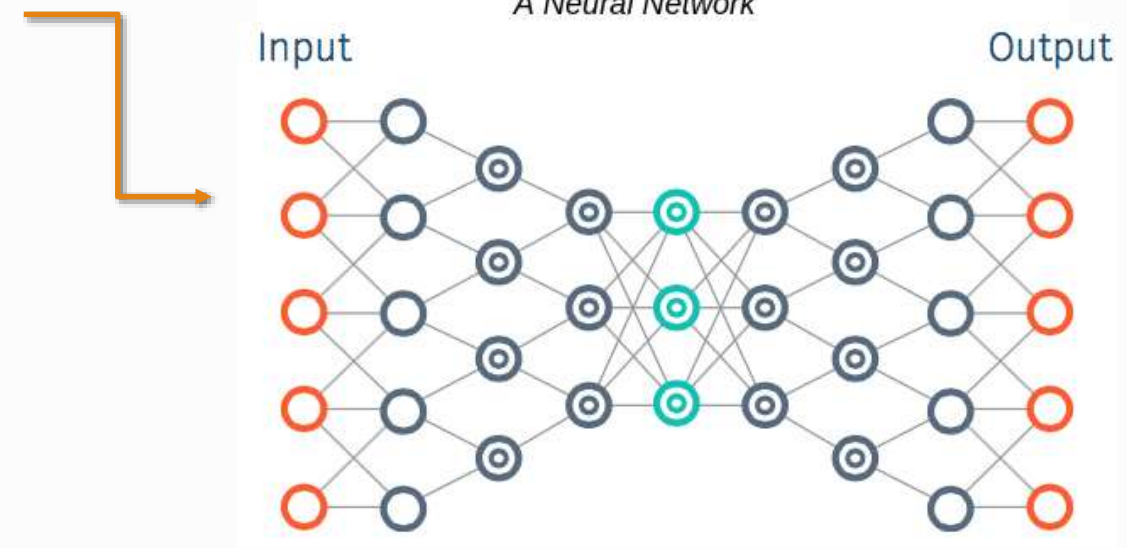
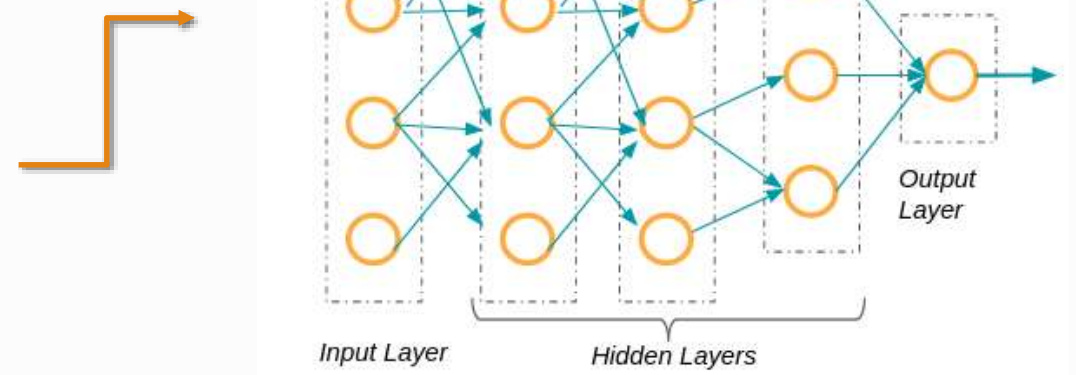

Community home, AI

- Conditional- Generative Adversarial Network

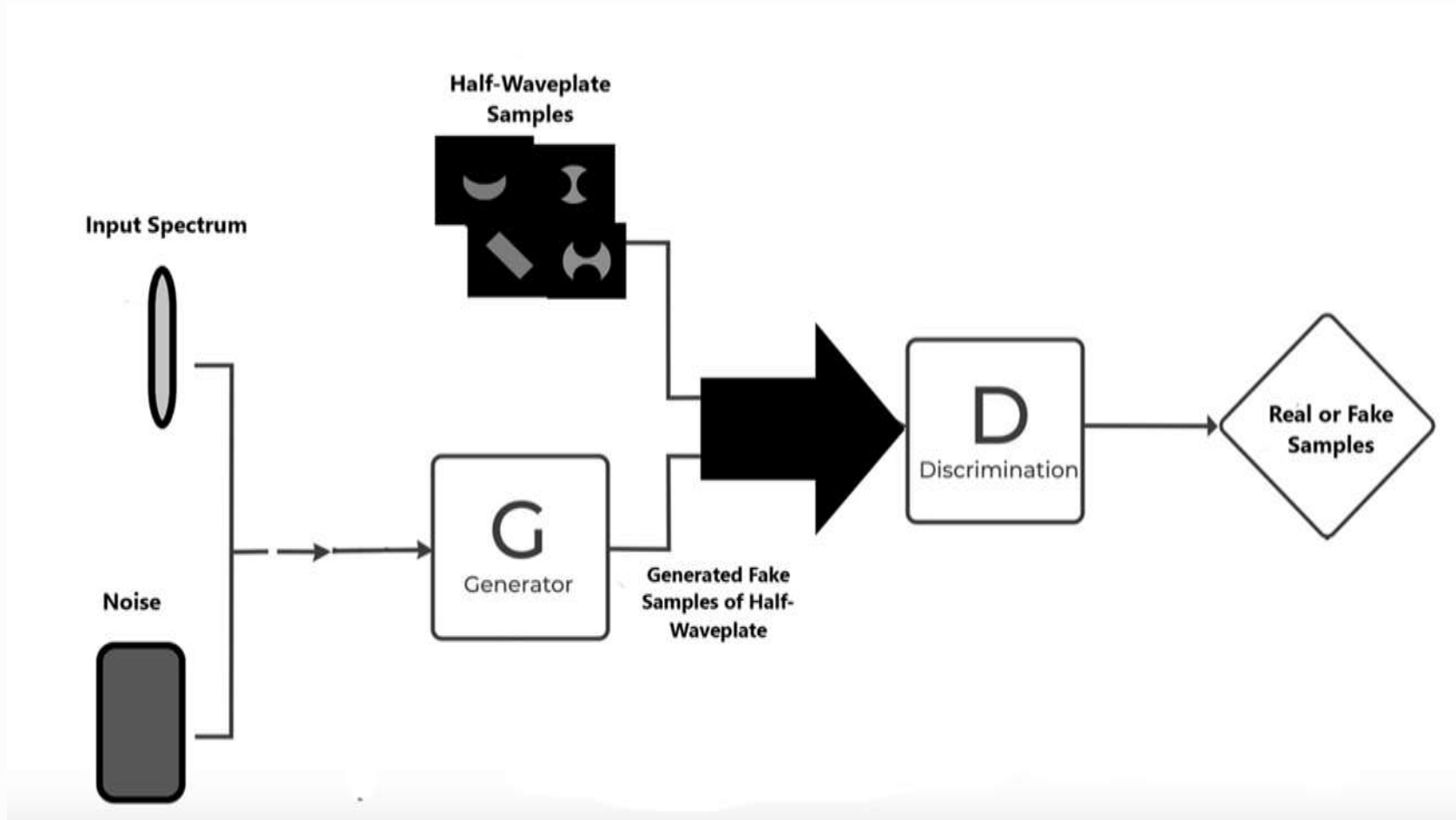

Modelling State of Polarization

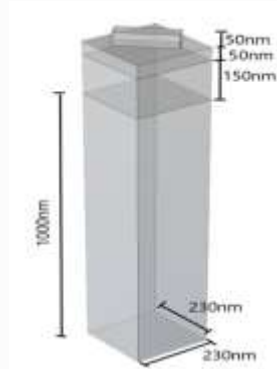
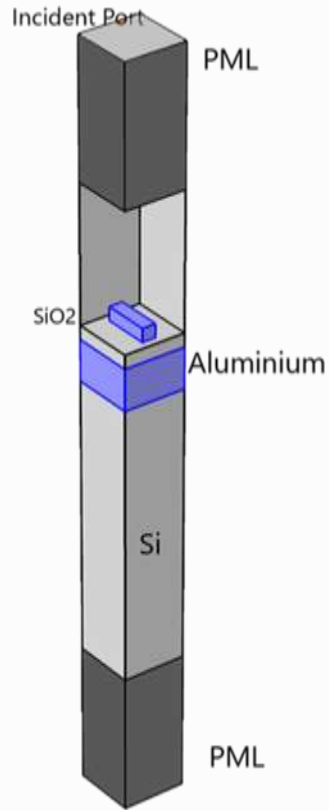

X-Polarization Incidence.

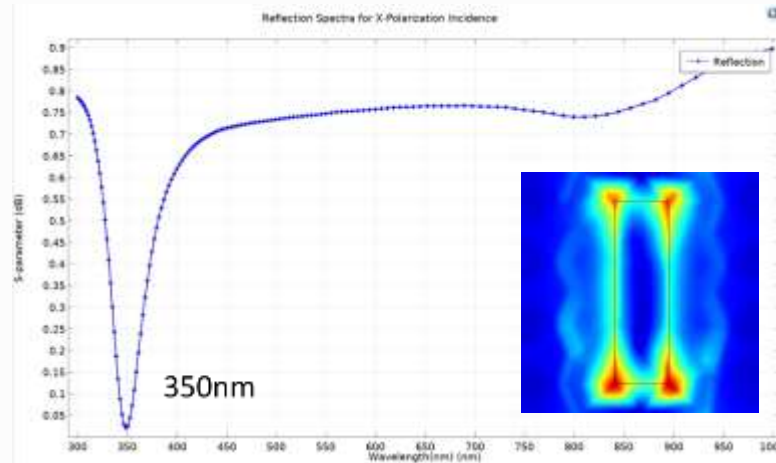

Y-Polarization Incidence.

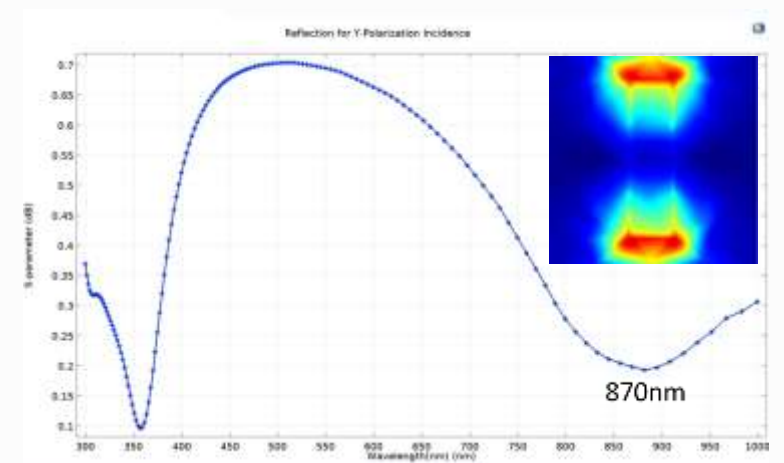

Phase difference between X- and Y-polarized.

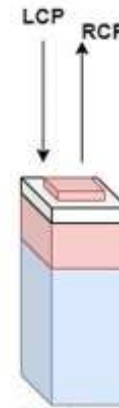
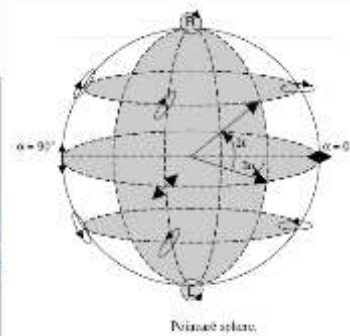
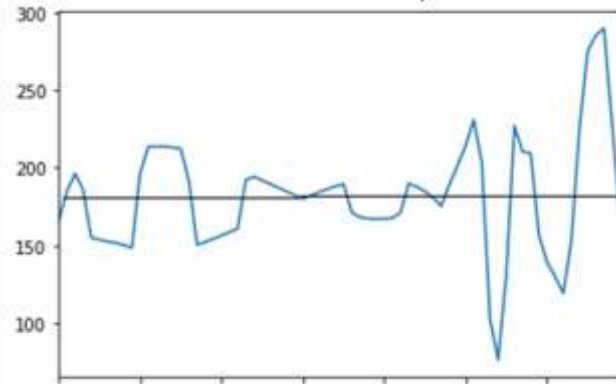

LCP to RCP conversion.

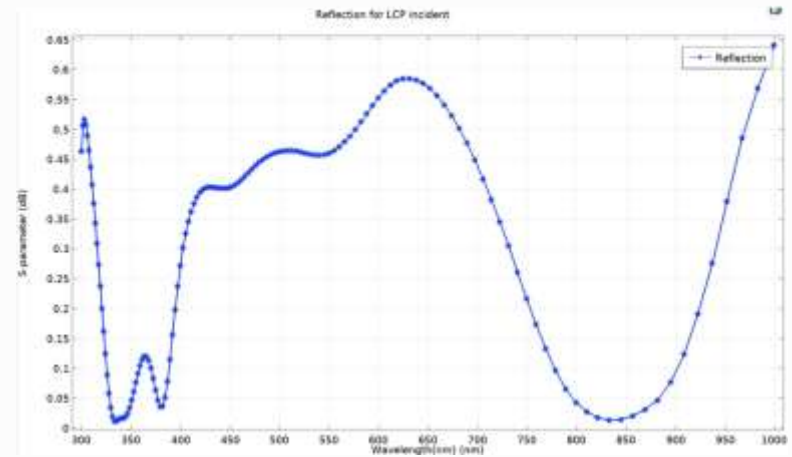

Can we achieve more efficiency?

Dataset Preparation.

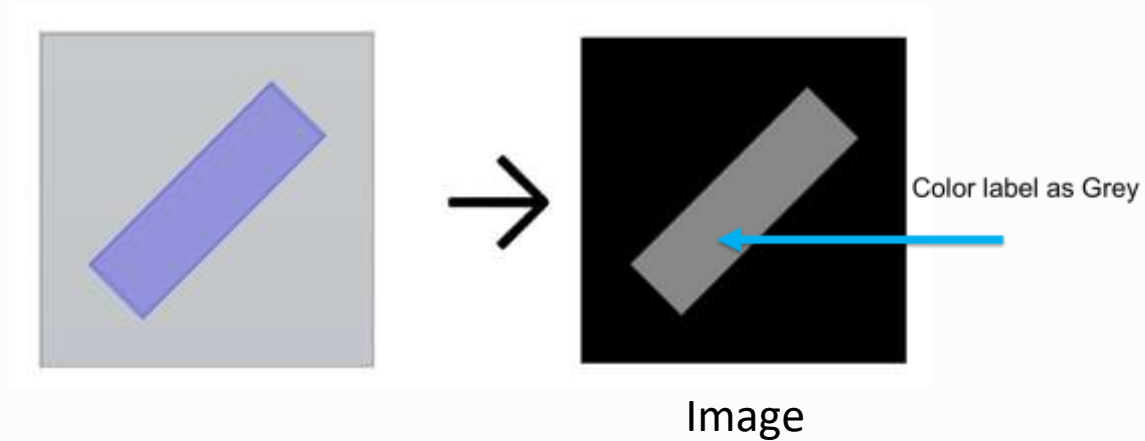

+

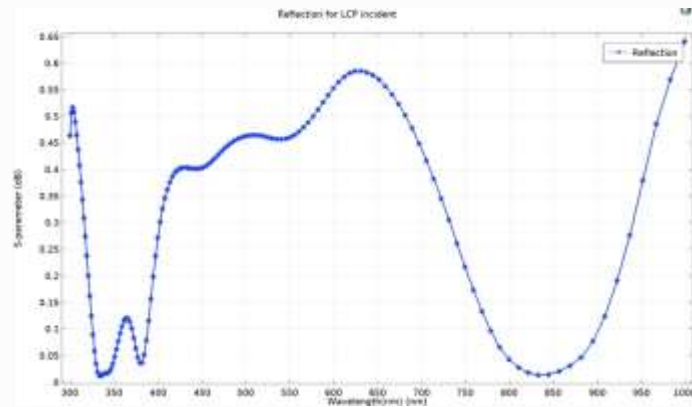

100-points vector spectrum

Half-waveplate Design Samples

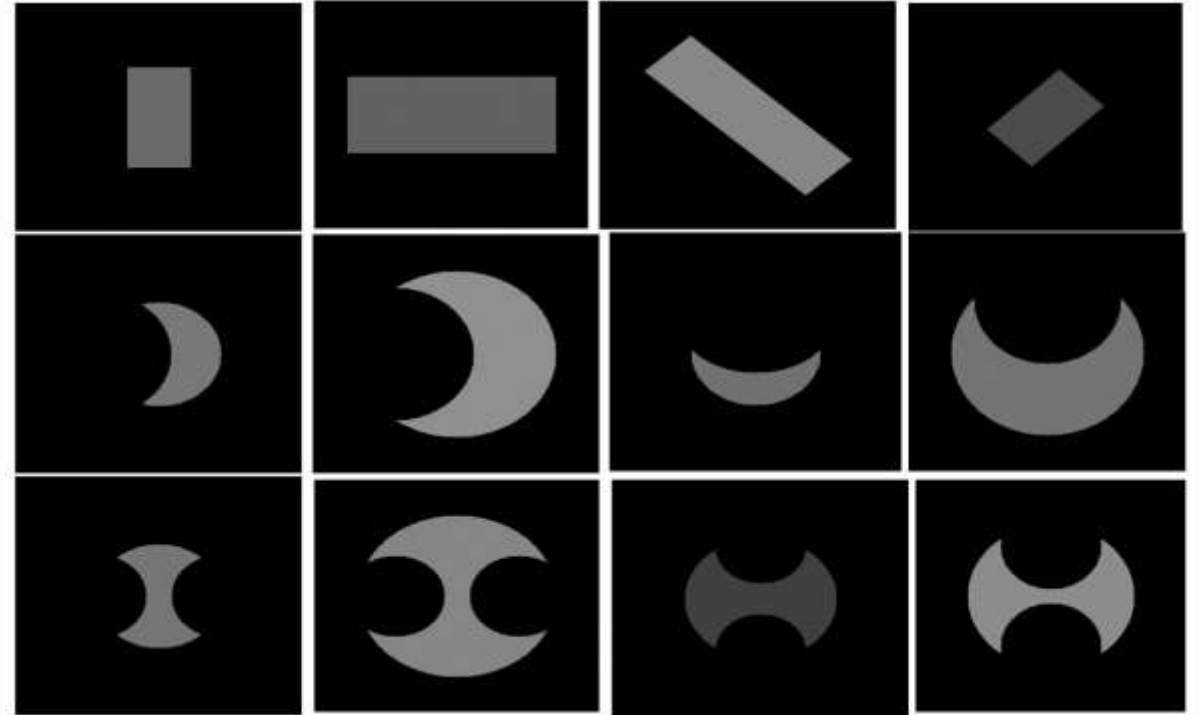

- 1000 Half-waveplate simulations using Livelink for MATLAB with random generation algorithm.

Training of Deep Learning Model

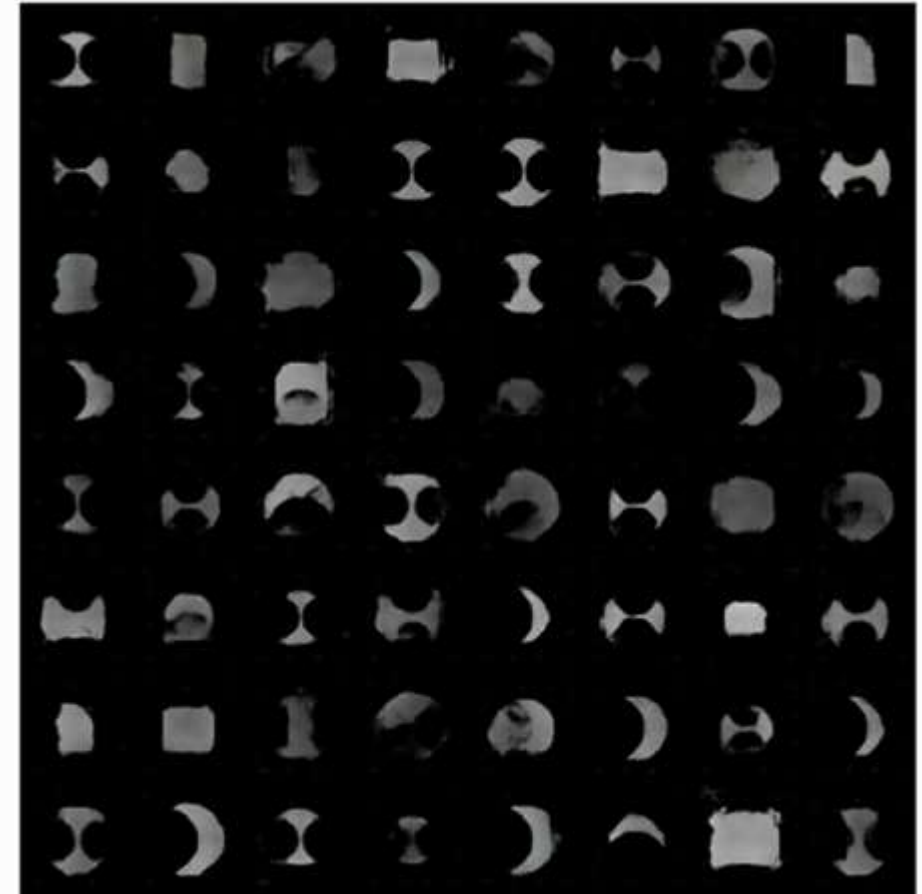
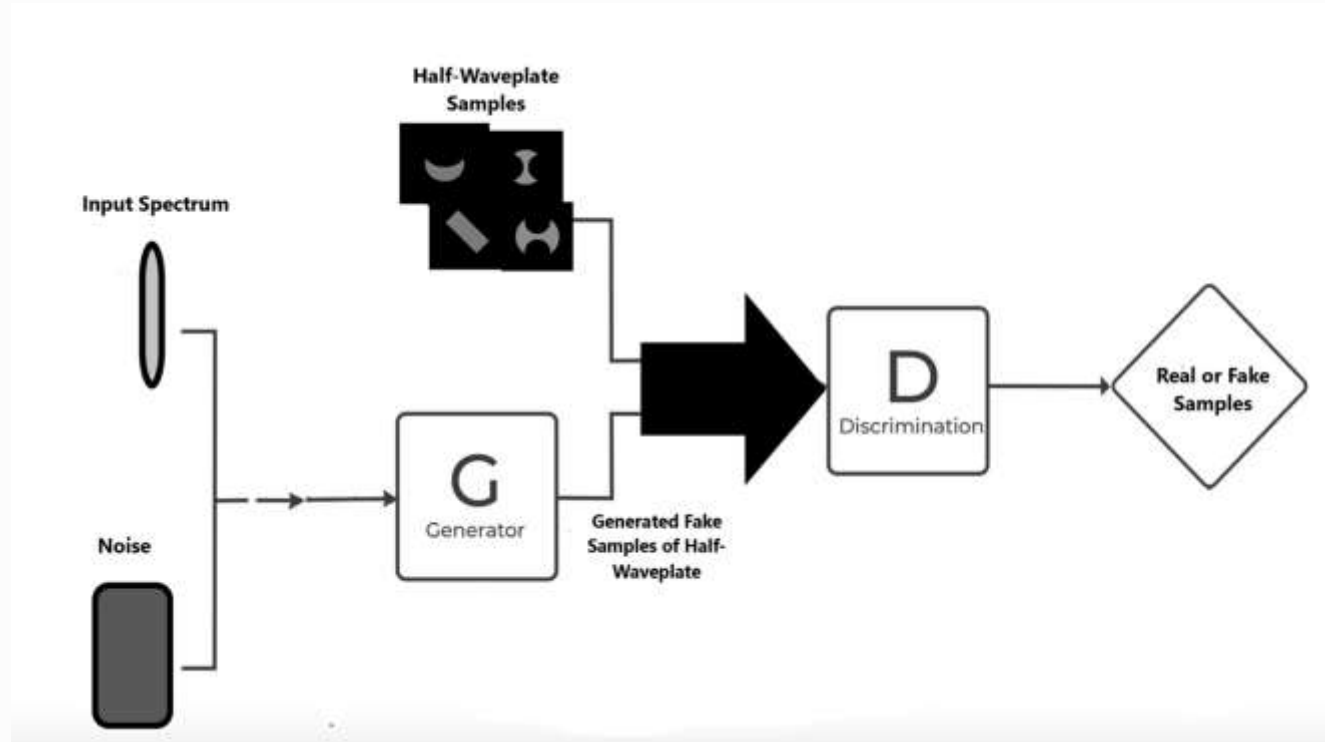

Conclusion:

- High-quality training device data using the combination of iterative optimizers and accurate electromagnetic solvers i.e. Finite Element Simulations using Comsol.
- Machine Learning models can learn correlations between device topology and its electromagnetic response.
- A data-driven design and characterization process for nanophotonic devices.
- Complex designs with multiple structural parameters could be learned using machine learning models.



thank you

